

This file has been cleaned of potential threats.

To view the reconstructed contents, please SCROLL DOWN to next page.

INSTITUTE FOR PLASMA RESEARCH

An Aided institute of department of Atomic Energy, Govt. of India)
Near Indira Bridge, Bhat. DIST.GANDHINAGAR - 382 428 (INDIA)
PHONE :(079-2396 2000),FAX :91-079-23962277
Web : www.ipr.res.in

MINOR FABRICATION WORKS ENQUIRY

Office Copy

ENQUIRY NO :IPR/MFW/21-22/110

Date : 28-09-2021

Due Date : 13-10-2021 13:00 IST

Please send your offer in sealed envelope specifying Inquiry No, Date & Due Date, ALONG WITH your credentials for the following items:

Important Note:

Please note that e-mail quotations are not acceptable however you may send your queries (if any) to **ranjana@ipr.res.in**

Please Ensure that your sealed quotation reaches this office not later than above mentioned due date and time.

Kindly go through the following document properly before Quoting which are available on the IPR web portal i.e., <http://www.ipr.res.in/documents/tenders.html/> attached here with.

1. Technical specification as enclosed.
2. Instruction to the bidders & terms and Condition (refer Form NO:**IPR-MFW-01-V1**)
3. Bidding format(refer Biddingformat MFW-Bid.pdf)

GST fro Goods and Services (IGST/CGST/SGST TAX BENEFITS): PLEASE REFER clause no:8 of Form No:**IPR-MFW-01-V1**

QUOTATION SHOULD BE ADDRESSED TO **RANJANA GANGRADEY** ONLY.

| Sr.No. | Description | Quantity | Rate |
|--------|---|----------|------|
| 1 | MS Pillar Fixation for Cryopump Lab Space as per the specifications | 1 | No. |

Free Issue Material

| Sr.No. | Description | Quantity | Unit | Value |
|--------|-------------|----------|------|-------|
|--------|-------------|----------|------|-------|

Note : Please quote with complete technical details (Technical Compliance sheet and product data sheet)

Encl:As per attachment

Sd/-
RANJANA GANGRADEY
Scientific Officer-G

Tender for MS Pillar Fixation for Cryopump Lab Space

A. Introduction:

Cryopump and Pellet Injector Lab, situated in the Ground floor of the New Lab building at Institute for Plasma Research, Gandhinagar, Gujarat is working for the development of Cryopump and Pellet injector Facilities. To provide the auxiliary supplies to the experimental facilities, MS Pillar fixation for cryopump lab is required. The MS pillars will provide the main support to the auxiliary supplies like Air, Water, Gases and cryogenic fluids.

B. Scope of the Work:

- Pre-fabricate the MS pillars and mounting boards at supplier's facilities.
- Major cutting, edge cleaning, fixer mounting will also be carried out by the vendor at their factory/facilities
- Supply of the MS Pillars and related supplies mentioned in the tender to IPR
- Fixing the MS pillar as per the mentioned space layout
- Necessary ground clearance, fixer pit creation, mounting for pillars, mounting boards is on supplier's scope.
- Fixing Cable tray as per the drawing.
- All the corner and height adjustment of the pillar and cable trays will be on vendor's scope.
- After Fixing and mounting boards rust protection and painting will be on vendor's scope.

C. Technical Specification/Compliance

| Sr. No. | Specification/Requirements | Vendor's Acceptance |
|---------|---|---------------------|
| 1. | <u>MS Pillar: 2m Height</u> Pillar size: Height 2m Pillar Channel type: C channel Channel size in mm: 100*50*5 Base plate size in mm:200*100*10 Stiffeners: As per drawing Quantity: 29 Nos. | Yes/No |
| 2 | <u>MS Long Pillar: 3m Height</u> Pillar size: Height 3m Pillar Channel type: C channel Channel size in mm: 100*50*5 Base plate size in mm:200*100*10 Top Fixers: As per drawing Stiffeners: As per drawing Quantity: 4 Nos. | Yes/No |
| 3. | <u>Mounting Board:</u> Size in mm: 3000*600*1.5 Fixing: To be fixed between pillars as per lay-out drawings Stiffeners: Appropriate stiffeners to be given on the plates Quantity: 19 Nos. | Yes/No |

| | | |
|----|--|--------|
| 4. | <p><u>Other necessary works</u></p> <ul style="list-style-type: none"> • Cable tray Mounting(Size in mm): 125*65 • Fixers: As per drawing and requirement • Anchoring: as per drawing and layout • Painting: Primer/anti-rust painting and then final painting color off-white. | Yes/No |
|----|--|--------|

D. Instruction to vendors:

- The works mentioned in this document needs to be thoroughly checked by the vendor before offering quotation.
- The laboratory floor area is concrete and cemented floor, therefore fixer tools will be as per the lab floor.
- Vendor must carry their own welding machine, gases and all the necessary tools to carry out the work at IPR.
- All personnel to be involved in this work order should be trained and should be aware of the safety precautions.
- All required safety equipment and accessories to the workers will have to be provided by the vendor
- The working hour will be as per the office timing and no work will be allowed on holidays.

E. Acceptance:

After the completion of the work IPR personnel will check the work as per the specification and after the site clearance acceptance will be given.

F. Delivery:

The work must be completed within three Months' time after the receipt of the purchase order. Before initiating the work at IPR, vendor must intimate one week earlier to enable us the gate pass and site availability.

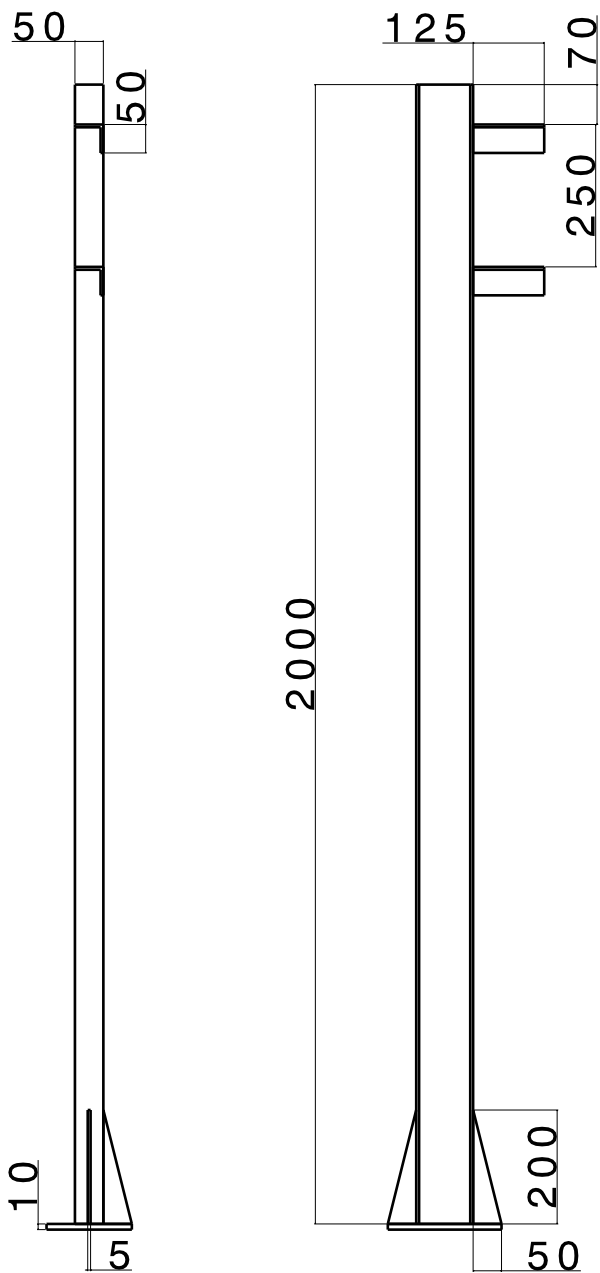

Front view

Left view

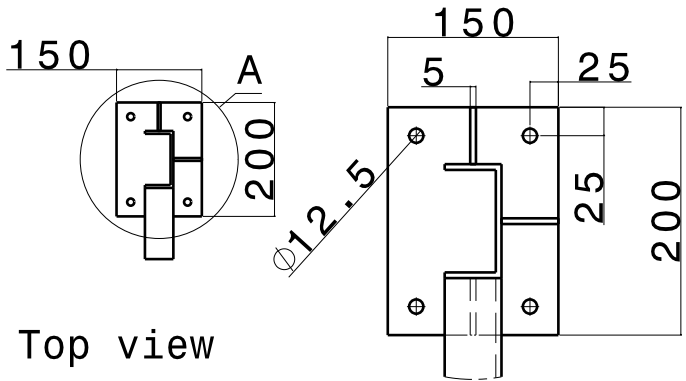

Top view

Detail A
Scale: 2:1

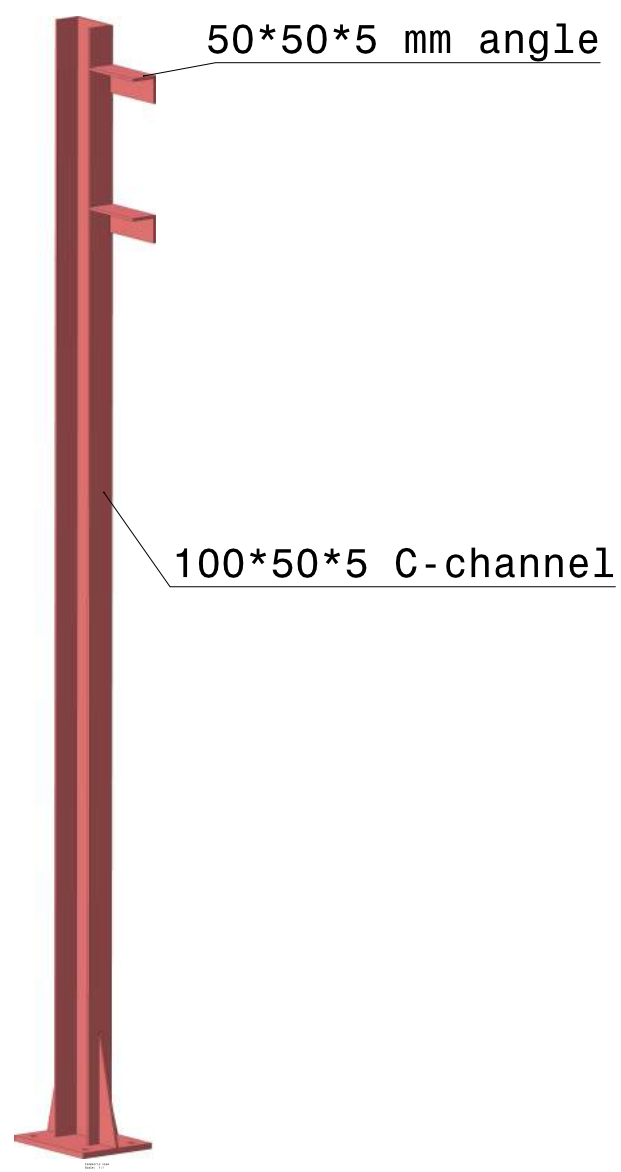

Qty.: 29
Material: M.S.

Pillar

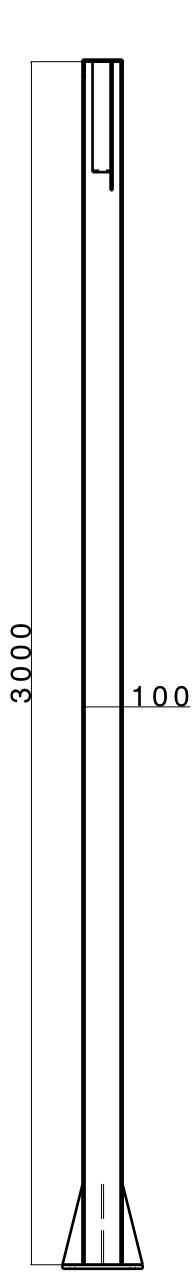

Right view
Scale: 1:1

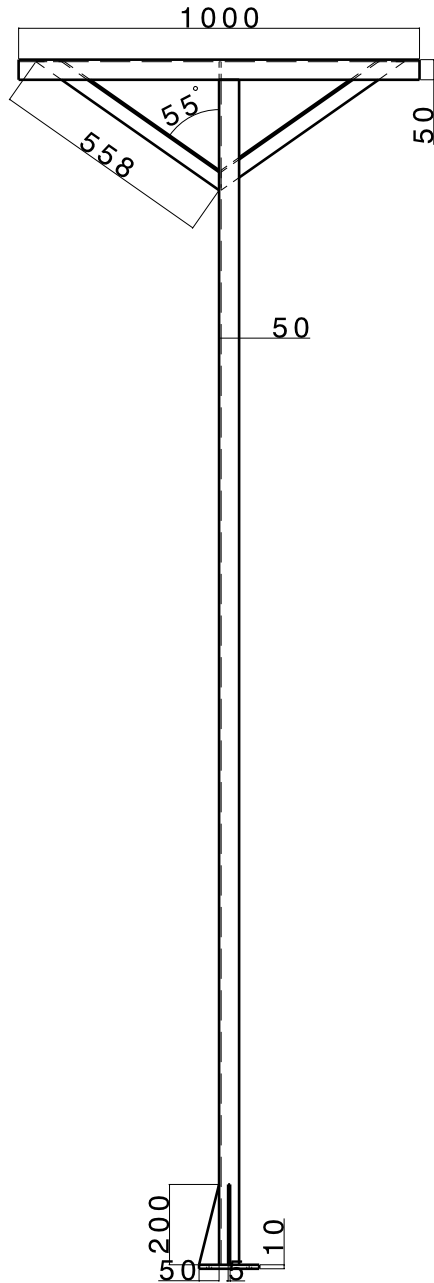

Front view
Scale: 1:1

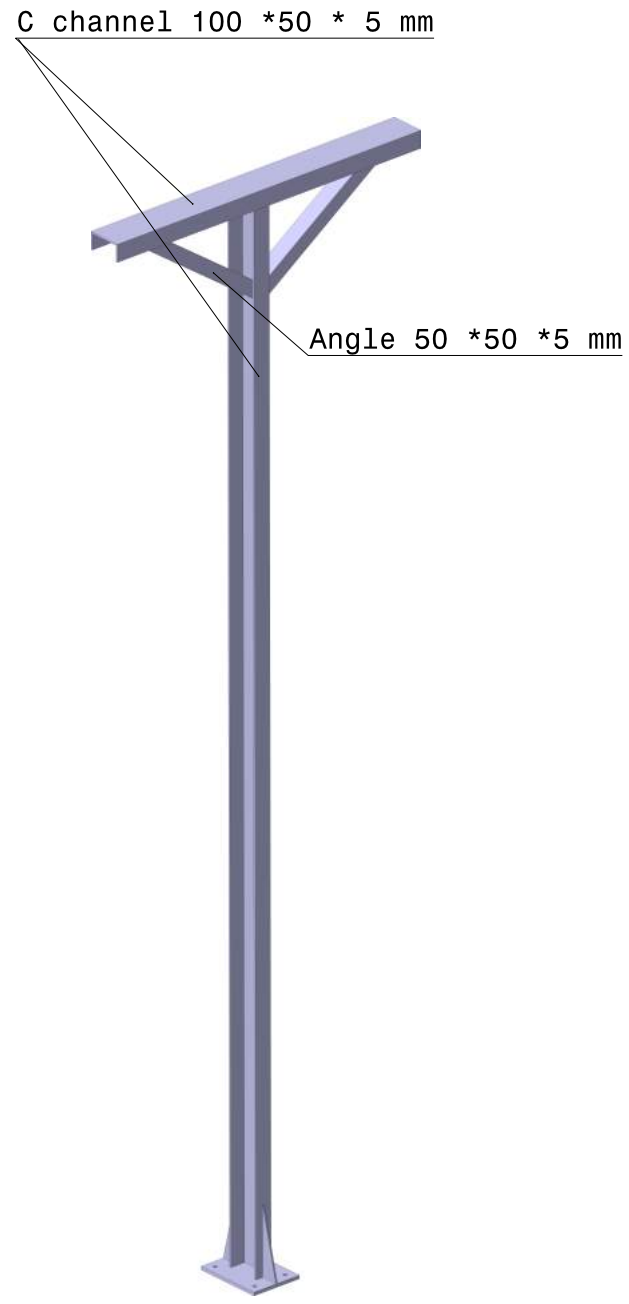

Isometric view
Scale: 1:1

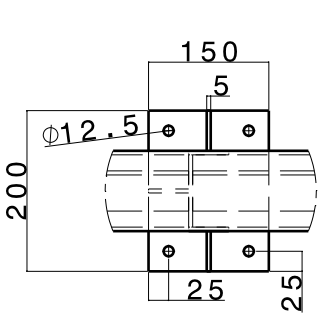

Detail B
Scale: 2:1

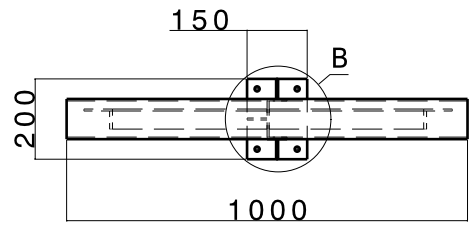

Top view
Scale: 1:1

Qty.: 04
Material: M.S.

Long Pillar

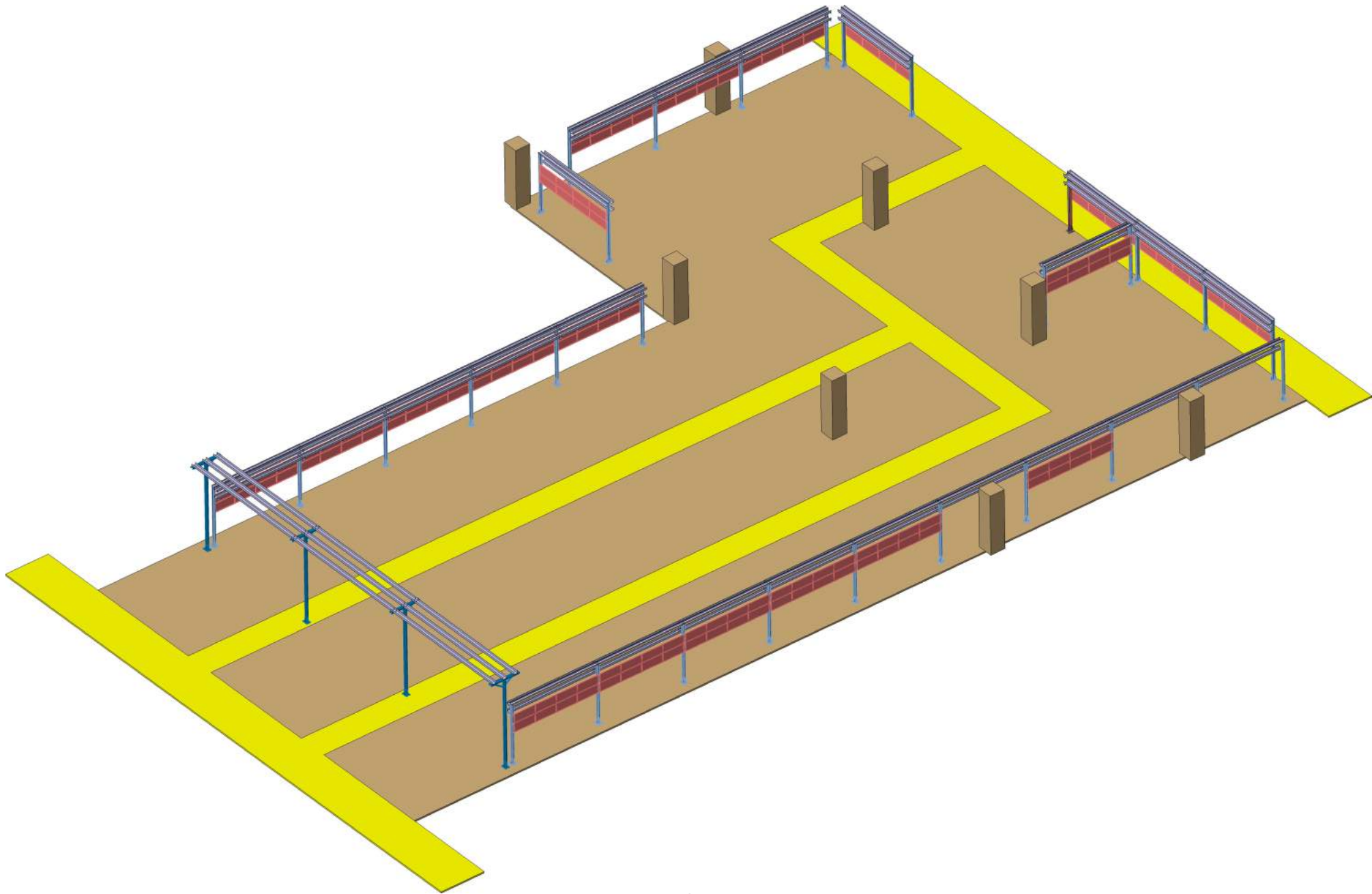

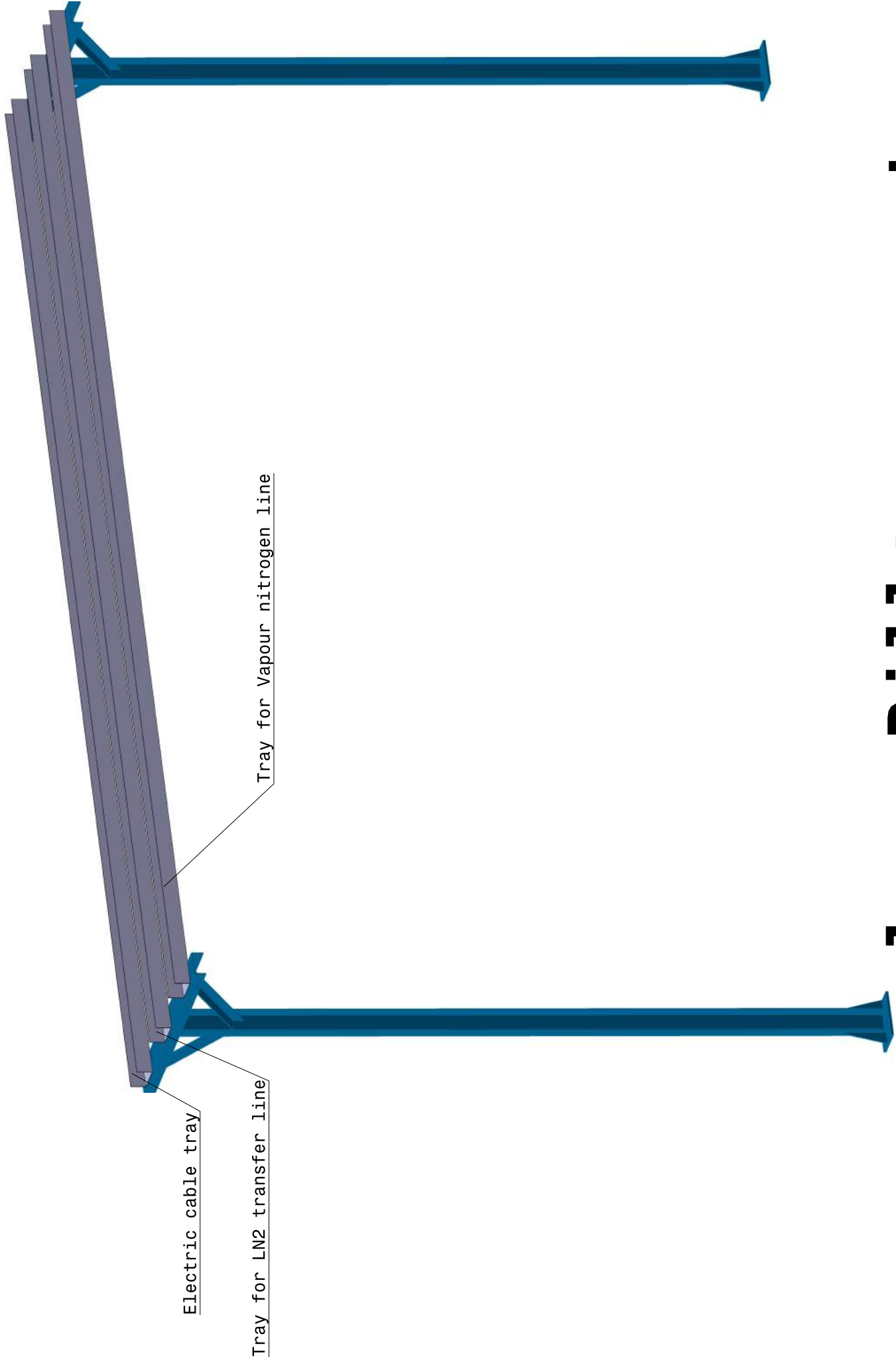

Electric cable tray

Tray for LN2 transfer line

Tray for Vapour nitrogen line

Long Pillar segment

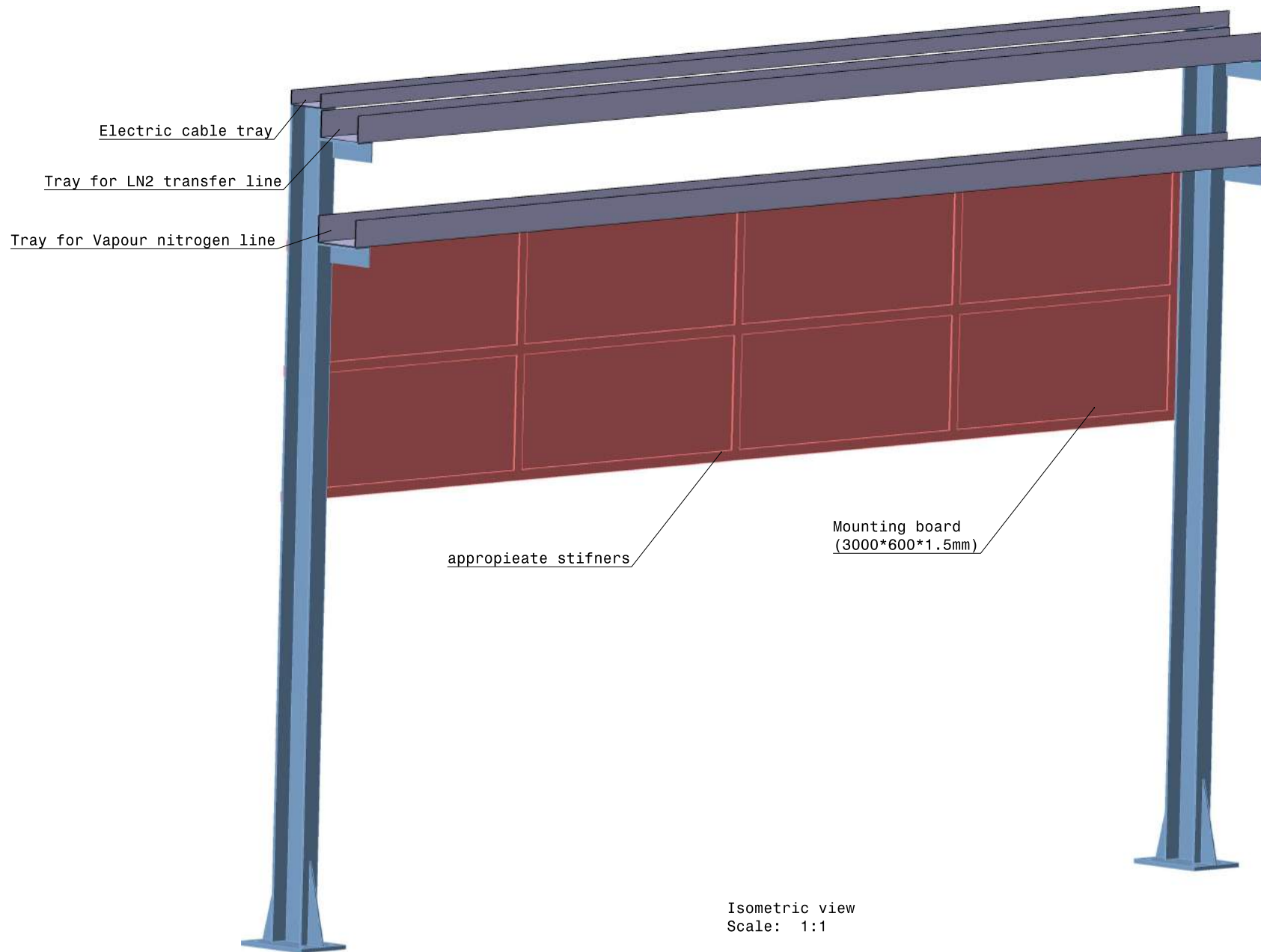

Pillar segment

(This need to be printed in Bidders letter head)

1. Please quote with complete technical details along with technical compliance sheet.
2. Quotation should be submitted in the format given below, else IPR shall not consider the offer by the vendor.

NAME OF PARTY : _____

ENQUIRY NO: _____

QUOTATION No. & DATE : _____

Currency of Quotation: **Indian Rupees**

| Sr. No. | Item Description | HSN/SAC Code | Quantity | Unit Rate (Basic) | Packaging & forwarding (P&F) | Applicable GST | Rate (incl P&F and GST) | Total Value |
|---------|------------------|--------------|----------|-------------------|------------------------------|----------------|-------------------------|-------------|
| | | | a | b | c | d | e = b + c + d | f = a * e |
| 1 | | | | | | | | |
| 2 | | | | | | | | |
| 3 | | | | | | | | |
| 4 | | | | | | | | |
| 5 | | | | | | | | |
| 6 | | | | | | | | |

| Sr. No. | Particular | Remarks |
|---------|--------------------------------|---------|
| I. | Ex-works / FOR Destination | |
| II. | Freight | |
| III. | Insurance | |
| IV. | Delivery Period | |
| V. | Payment (IPR terms will apply) | |
| VI. | Guarantee / Warrantee | |
| VII. | Validity Period | |
| VIII. | Discount (if any) | |
| IX. | Remarks | |

Place: Authority Signatory

Date: Company Seal

Note:

1. Bidder should submit the copy of GSTIN / ARN Certificate along with the offer
2. Bidder should specify the SUPPLY and SERVICE rates/ charges separately wherever applicable



Form No: IPR-MFW-01.V1

INSTRUCTIONS TO BIDDERS AND TERMS AND CONDITIONS

1. The Quotation and any order resulting from this enquiry shall be governed by our Conditions of Work Order and Contractor quoting this enquiry shall be deemed to have read and understood the same completely.
2. Where counter terms and conditions have been offered by the Tenderer, the same shall not be deemed to have been accepted by IPR unless our specific written acceptance thereof is obtained.
3. **Quotation:** Quotation should be submitted in the prescribed QUOTATION FORMAT attached with this Enquiry and the same should be submitted in a sealed envelope super-scribing the same with our enquiry No., date, due date and brief description of item on or before the due date. Late/delayed/incomplete/unsigned quotations will not be considered. Envelopes received without Enquiry number, date, due date and brief description of item may be rejected. The quoted prices should be firm for a period of 90 days from due date for placing order. IPR is not bound to accept lowest rate/s. IPR reserves the right to place on one or more parties. The scope of supply includes insurance by the Contractor.
4. **Specifications:** Goods should be offered strictly confirming to our specifications/drawings. Deviation, if any, should be clearly indicated by the contractor in their quotation. The Tenderer should also indicate the Make/Type number of the goods offered and catalogues, technical literature and samples, wherever necessary should accompany the quotation. Clarification/s on drawings should be obtained before submitting quotation.
5. **Terms of Prices:** Quotation should be submitted on door delivery basis without extra charge wherever possible. For quotations on Ex-Works, Ex-godown basis the approximate packing and forwarding charges should be indicated by the contractor. In the case of local contractors, the goods are to be delivered at our stores free of charge.
- 5.1 In respect of tenders on Ex-works basis, in case the tenderer has not mentioned in the offer packing, forwarding and transportation charges for safe delivery up to Purchaser's site, 2% of the price quoted towards packing (in respect of both local and outstation firms), 1% of the basic price quoted towards safe delivery charges in respect of local tenderer and 3% of the basic price quoted towards safe delivery charges in respect of outstation firm will be added for comparison of offers on safe door delivery at Purchaser's site.
- 5.2 Prices are required to be quoted according to the units indicated in the tender form/Enquiry. When Quotations are given in terms of units other than those specified in the tender form, relationship between the two sets of units must be furnished
6. Tender should be free from Correction and Erasures. Corrections, if any, must be attested. All amounts shall be indicated both in words as well as in figures. Where there is difference between amounts quoted in words and figures, amount quoted in words shall prevail. Unsigned quotations will summarily be rejected. If there is a discrepancy between the unit price and total price, unit price shall prevail.
7. IPR shall be under no obligation to accept the lowest or any tender and reserves the right of acceptance of the whole or any part of the tender or portion of the quantity offered and the tenderers shall supply the same at the rate quoted.
8. **Goods & Services Tax (GST):** The details of Taxes/GST and other levies legally applicable and intended to be claimed should be clearly indicated in the tender. Where this is not done, no claim on these accounts would be admissible later.

a) GST for Goods (IGST/CGST/SGST TAX BENEFITS):

IPR is entitled to avail tax benefit as per the following notifications issued by Ministry of Finance, Department of Revenue, Government of India:

(1) No: 47/2017-INTEGRATED TAX (RATE) DATED 14/11/17 for IGST

(2) No: 45/2017-CENTRAL TAX (RATE) DATED 14/11/17 for CGST

And,

IPR is entitled to avail tax benefit as per the following notifications issued by Finance Department, Government of Gujarat:

(1) No. 45/2017-STATE TAX (RATE) DATED 15/11/17 for SGST

As per above notifications IPR will bear only 5% IGST for procurement of goods from outside Gujarat & 2.5% CGST and 2.5% SGST (total 5%) for procurement of goods within Gujarat. Vendors are required to charge tax as per these notifications while quoting/supplying the goods. Deviations, (if any) should be clearly mentioned in the quotation/offer.

Please specify the HSN codes while quoting.

b) GST for Services:

As applicable. **Specify the SAC codes wherever services are involved.**

9. **Delivery Date:** Delivery period is essence of the Contract. Contractor must indicate the firm delivery date by which the goods will be dispatched or delivered by them from the date of our order. Delivery period shall be clearly



प्लाज़्मा अनुसंधान संस्थान

) भाट, इन्दौरा पुल के पास, गांधीनगर - 382428, गुजरात (भारत)

Institute for Plasma Research

Bhat, Near Indira Bridge, Gandhinagar - 382428, Gujarat (INDIA)

Phone: +91-79-23962000 Fax: +91-79-23962277 Website: www.ipr.res.in



- indicated against each item separately.
10. **Price/ Purchase Preference:** Purchase/Price preference to industries will be given as per the policy of the Government of India in force at the time of evaluation provided their offer is in compliance with the conditions of the policy.
 11. **Liquidated Damages:** The successful Vendor/Bidder should pay liquidated damages @ ½% (half percent) of the total work order value for the delay of each week in the scheduled date of completion of the work envisaged in the Work Order subject to a maximum of 5% (Five percent) of the total Work Order value.
 12. **Inspection:** Goods on its arrival at IPR will be inspected by Stores, and his decision in the matter will be final. However, where the items are required to be inspected at the Contractors Premises, Contractor has to give advance notice regarding readiness of the Goods to enable us to depute our representative for inspection.
 13. **Payment:** Payment will be arranged for accepted goods only within 30 days from the date of receipt of goods at IPR and bills in our accounts section, completed in all respects.
 14. No correspondence will be entertained within 30 days from the date of receipt of good and bills, whichever is later.
 15. **Guarantee:** The Stores offered should be guaranteed for a minimum period of twelve months, from that date of acceptance, against defective Goods, design, workmanship, operation or manufacture. For defects noticed and communicated during the Guarantee period, replacement/rectification should be arranged free of cost within a reasonable period of such notifications. In case where our specifications call for a guarantee period more than 12 months specifically, then such a period shall apply.
 16. **Performance Bank Guarantee:** If demanded by IPR, the successful bidder will have to furnish Performance Bank Guarantee for 10% of the order value (basic price) from a Nationalized/Scheduled Bank/State Bank of India, valid throughout the Guarantee/Warranty period. The scheduled banks approved by IPR are Axis Bank, HDFC Bank, ICICI Bank and IDBI Bank. Bank Guarantees submitted other than from banks approved by IPR will not be accepted.
 17. **Security Deposit:** If demanded the successful Bidder will have to furnish to the Purchaser an interest free security deposit for 10% (Ten percent) of the order value in the form of Bank Guarantee of an equivalent amount from a nationalized/ scheduled Bank/State Bank of India within 15 days from the date of work order and the said Guarantee should be valid till the goods are accepted by IPR. The scheduled banks approved by IPR are Axis Bank, HDFC Bank, ICICI Bank and IDBI Bank. Bank Guarantees submitted other than from banks approved by IPR will not be accepted. The Security deposit shall be forfeited in case the selected Bidder does not start the work within the time limit specified or fail to complete the work within the stipulated delivery period or fail to comply with any of the terms and conditions in the work order. On successful completion of scope of work and its acceptance by IPR, Contractor should send a letter requesting return of the original BG.
 18. The Contractor shall at all times indemnify the purchase against all claims which may be made in respect of the stores for infringement of any right protected by Patent Registration of design or Trade Mark and shall take all risk of accidents or damage, which may cause failure of supply from whatever cause arising and the entire responsibility for sufficiency of all means used by him for the fulfilment of the contract.
 19. **Free Issue Material (FIM):** Successful tenderer will have to arrange insurance showing beneficiary as "Institute for Plasma Research" at their risk and cost towards adequate security for the materials/property provided/issued by the Purchaser as Free Issue Material for the due execution of the contract.
 20. The Director, IPR reserves the right to accept or reject any quotations fully or partly or to cancel the enquiry without assigning any reason.
 21. **Jurisdiction:** The contract shall be governed by the Laws of India for the time being in force. The Courts of Gandhinagar only shall have jurisdiction to deal with and decide any legal or dispute arising out of this Contract.